

SERIES:

MGDN4



tyco Electronics

3003 9th Avenue SW
PO Box 50
Watertown, SD 57201
Toll free: 888-978-2638
Ph: 605-886-3326
Fax: 605-886-8995



Low Profile, High Current Power Inductors

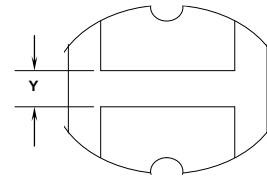
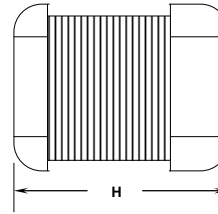
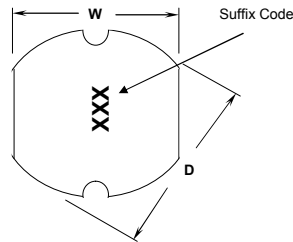
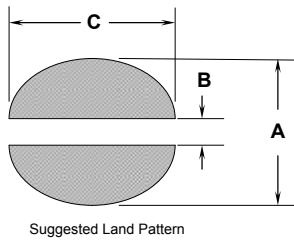

Series Number	Maximum Dimensions				Reference Dimensions			
	Units	L	W	H	Y	A	B	C
MGDN4	inches	0.319"	0.287"	0.217"	0.083"	0.346"	0.083"	0.287"
	[mm]	[8.10]	[7.30]	[5.50]	[2.10]	[8.80]	[2.10]	[7.30]

Features:

- High energy storage and low resistance
- Reliable surface mounting, flat top for pick and place.
- Smaller real estate than other common inductors.
- Robust temperature deflection to prevent damage during solder reflow.
- Tape and Reel mechanical specifications available upon request.
- Operating Temperature -40°C to +85°C.
- Highly resistive core for EMI suppression applications.

Notes:

- Inductance measured at 100kHz and 250mVrms.
- Isat is a maximum applied AC + DC current.
- Isat current is applied to produce a typical 35% drop in nominal inductance.
- Tolerance suffix of M = ±20%.
- DCR is a maximum at 20°C.

260°C Maximum reflow temperature per J-STD020
Terminal Plating is Hot Dipped SnAgCu



Schematic Diagram

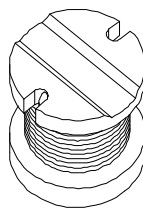
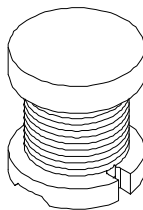
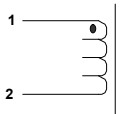

Contact CoEv for additional inductance values

MGDN4				
Lead Free Part Number	L μH	DCR	IsAT	Tolerance
		W	A	Suffix
	1.0			
	1.4			
	1.8			
	2.2			
	2.7			
	3.3			
	3.9			
	4.7			
	5.6			
	6.8			
	8.2			
MGDN4-00001	10	0.07	2.30	K
MGDN4-00002	12	0.08	2.00	K
MGDN4-00003	15	0.09	1.80	K
MGDN4-00004	18	0.10	1.60	K
MGDN4-00005	22	0.11	1.50	K
MGDN4-00006	27	0.12	1.30	K
MGDN4-00007	33	0.13	1.20	K
MGDN4-00008	39	0.16	1.10	K
MGDN4-00009	47	0.18	1.10	K
MGDN4-00010	56	0.24	0.94	K
MGDN4-00011	68	0.28	0.85	K
MGDN4-00012	82	0.37	0.78	K
MGDN4-00013	100	0.43	0.72	K
MGDN4-00014	120	0.47	0.66	K
MGDN4-00015	150	0.64	0.58	K
MGDN4-00016	180	0.71	0.51	K
MGDN4-00017	220	0.96	0.49	K
MGDN4-00018	270	1.11	0.42	K
MGDN4-00019	330	1.26	0.40	K
MGDN4-00020	390	1.77	0.36	K
MGDN4-00021	470	1.96	0.34	K
	560			
	680			
	820			
	1000			

Specifications subject to change

Call Toll Free: 888-978-2638 Website: www.tycopowercomponents.com

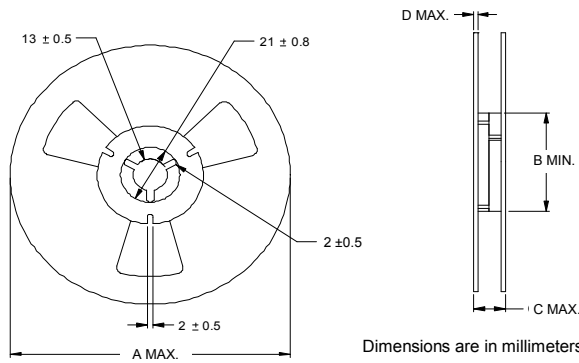

Series Number	Reel dimensions				Reel Qty	Carton (Box) Qty.	Packaging Specification	
	Units	A	B	C				D
MGDN4	in.	12.99"	4.02"	0.87"	0.106"	1000	6000	90-0048
	[mm]	[330]	[102.0]	[22.2]	[2.70]			

PACKAGING NOTE: Only pressure sensitive cover tape is to be used.

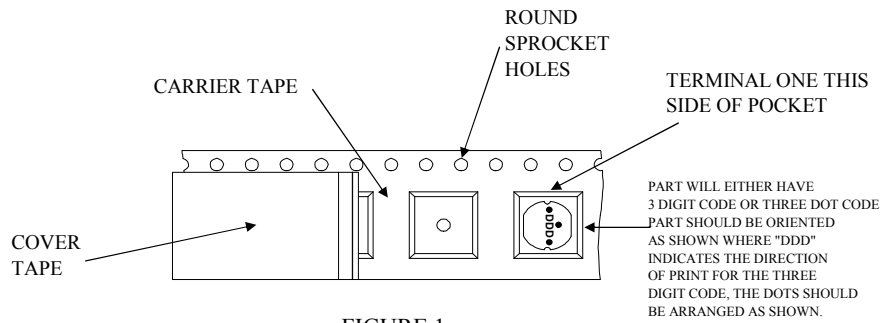
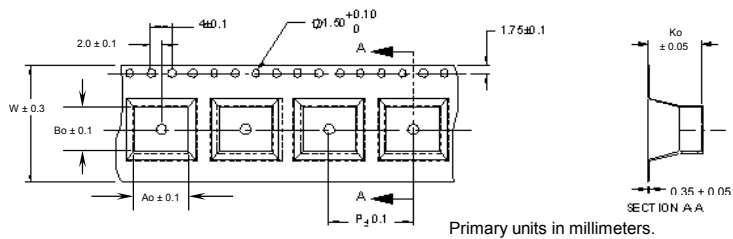

FIGURE 1
CARRIER TAPE AND PART



Series	Ao	Bo	W	P	Ko
MGDN4	7.14	7.94	16.0	12.0	5.68



Customer Packaging Specifications
For Print Distribution to Customers

Series	Revision
MGDN4	A0
Sheet 2 of 3	

Item	Specification	Test Method/Condition
Environmental		
Static Humidity	After exposure part remains within specified electrical parameters for L, Q and DCR.	Expose parts to an environment of +50°C with 90 to 95% R.H. for 100 hours. After exposure, allow parts to dry for 2 hours before measurements are taken.
Storage Life	After exposure part remains within specified electrical parameters for L, Q and DCR.	Subject parts to an environment of +50°C 90 to 100% R.H. for 46 to 50 hours. After exposure, allow parts to dry for 2 hours before measurements are taken.
Moisture Resistance	After exposure, part shall not have a shorted or open winding.	Per MIL-STD 202 Method 106, ten 24 hour cycles at +25°C to +65°C at 80 to 95% R.H. During any of the first 9 cycles, inductors are revolved from the chamber and exposed to -10°C for 3 hours. Allow parts to dry for 2 hours before measurements are taken.
Temperature Cycle	After exposure part remains within specified electrical parameters for L, Q and DCR.	10 cycles (Air to Air) 1 cycle shall consist of: 30 minutes exposure to +85°C 30 minutes exposure to -40°C Allow 20 minutes transition between extremes.
Temperature Shock	After exposure part remains within specified electrical parameters for L, Q and DCR.	10 cycles (Air to Air) 1 cycle shall consist of: 30 minutes exposure to -45°C 30 minutes exposure to +125°C 15 seconds maximum transition between temperatures
General		
Storage Temperature Range	-40°C to +85°C	
Operating Temperature Range	-40°C to +85°C	
Flammability	IEC 695-2-2	Withstands needle-flame test
Other		
Vibration	After exposure part remains within specified electrical parameters for L, Q and DCR.	Inductors shall be randomly vibrated per NAVMAT P9492 profile. Samples shall be subjected to 0.04G/Hz for a minimum of 15 minutes per axis, for each of the three axes.
Mechanical Shock	After exposure part remains within specified electrical parameters for L, Q and DCR.	Test per MIL-STD 202 method 213 test condition A, test mounted samples 3 axes, 6 times, totaling 18 shocks. (50Gs, 11ms, half-sine).
Solderability	Wetting shall cover 90% minimum of each termination	Dip pads in RMA flux, 63/37 solder (Sn/Pb) at 232°C for 5 seconds ±2 seconds.
Component Adhesion (Push Test)	4 pounds	Apply and measure force with a digital force gauge set.
Resistance to Solvent	No sign of degradation in appearance or marking detail.	Withstands 6 minutes of alcohol. Withstands 3 minutes forced spray Freon TMS
Load Life	After exposure, part shall not have a shorted or open winding.	Parts to be stored at 110°C for 1000 hours with rated current applied. Parts to be tested at: start, 500 and 1000 hours. Allow 2 hours at room temperature before testing.



For Print Distribution to Customers	Series	Revision
	MGDN4	A0
	Sheet 3 of 3	